

HIPERBARIC AFTERMARKET PARTS

2022 Catalog

Why HPP Advisors?



HPPADVISORS

“What is Truly Unique to our Approach is our Customer Inward Approach to product development and coming to Market”

- We source "Made in USA" first and foremost with Certified Suppliers
- Our customers are involved from Day 1 in bringing our Products to Market
- We stand behind our Parts with Industry only Cycle Warranty
- We offer a 15% Discount off the OEM List Price AND
 - Volume Discount Pricing
- Our Supply Chain Management ensures you have Parts when you need them!



Why HPP Advisors?

Our Suppliers have been in the machine metal service for over a combined 60 years in the Midwest United States. This commitment to utilizing the most experienced craftsmanship affords HPP Advisors to produce only the highest quality Hiperbaric Aftermarket Wear Parts, such as, High Pressure Fittings, Intensifier Parts and Decompression Parts for the HPP Food Industry.

Our Hiperbaric Equipment Customers have been in the HPP Industry since the very beginning, it is their invaluable insight into our Hiperbaric Aftermarket Wear Parts that is the backbone to our platform of High Pressure Parts for the Hiperbaric 50L, 300L, 420L, and 525L Models. These same customers that provide their wealth of experience in maintaining these machines, also provide the rigorous field testing that is needed before any product is introduced into the marketplace.

HPP Advisors only business is High Pressure Processing for the Food Industry. Our parts are tailored to the Industry Standard Operating Pressure of 87,000 psi/600 MPa. It is for this reason we can offer our fittings to our customers at affordable pricing over the OEM.

High Cycle HP160 101k Tubing



3/8" and 9/16"

- ✓ Cone and Thread Connections
- ✓ High Strength Stainless Steel with Good Corrosion Resistance
- ✓ 22' – 24' Random / Cut in 1/2
No Charge



3/8" Custom Bending

- ✓ We have Stock when others Don't
- ✓ High Strength Stainless Steel with Good Corrosion Resistance
- ✓ Nipples



HPPADVISORS

High Pressure Fittings



Compatible with the following HPP Equipment

- 55L
 - 120L
 - 135L
 - 300L
 - 420L
 - 525L
- ✓ Operating Pressure 87k (6000 Bar)
 - ✓ Excellent Mechanical Properties for Food Production Environments
 - ✓ High Strength Stainless Steel with Good Corrosion Resistance
 - ✓ Cone and Thread Connections
 - ✓ Part Number, Serial Number Traceability

Existing Aftermarket Parts

Our Selection of Parts increases based upon customer demand.

If you don't see a part you are looking for let us know and we will do our best to fulfill your request!

We included below each part the Original Manufacture Part Number when available, and List Price for your convenience!



HPPADVISORS



Fittings, Gland Nuts, Collars, Plugs



HPPADVISORS

- ✓ Gland Nuts come standard with Hexagonal Heads



- ✓ Fittings come in any configuration of 9/16" x 3/8"

Plugs, Gland Nuts, Collars



HPPADVISORS

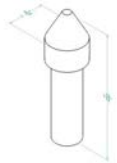

HPPA-00-00P3
Standard 3/8" Plug
H04-025-09002



HPPA-00-00G3
Standard 3/8" Gland Nut



HPPA-00-00C3
Standard 3/8" Collar
Flow A-2839



HPPA-00-00C9
Standard 9/16" Collar

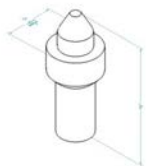

HPPA-00-00P9
Standard 9/16" Plug
H04-025-40-09001



HPPA-00-00G9
Standard 9/16" Gland Nut



HPPA-00-0093
Standard 3/8" to 9/16 Adapter
H04-025-40-05009

Fittings, Valves

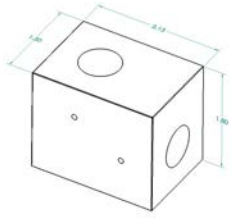

HPPA-00-00E3
*Standard 3/8" Elbow
#H04-025-40-02006

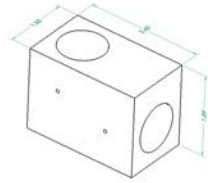

HPPA-00-00E9
*Standard 9/16" Elbow
H04-025-40-02002

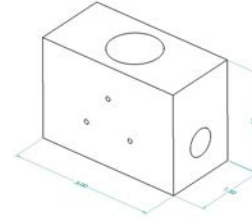

HPPA-00-OCT3
*Standard Combo
3/8" x 3/8" x 9/16" Tee
H04-025-40-03018

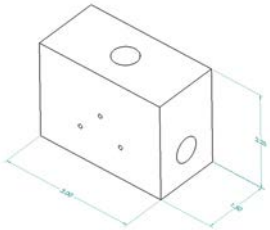

HPPA-00-00T3
*Standard 3/8" Tee
H04-025-40-03017

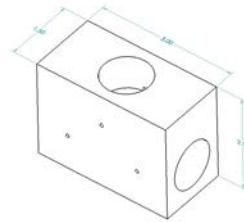

HPPA-00-00T9
*Standard 9/16" Tee,
H04-025-40-03011

* All Fittings come with Gland Nuts and Collars

Fittings, Valves

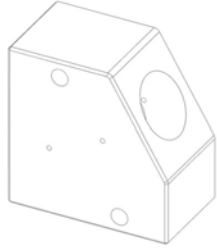

HPPA-HB-B6E9

***Standard 130 Degree
9/16" Elbow
H04-025-40-02004**

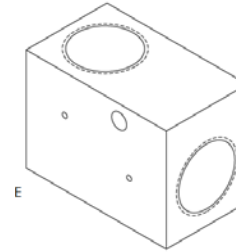

HPPA-HB-00E9

***Standard 9/16" Elbow
H04-025-40-02002-M**

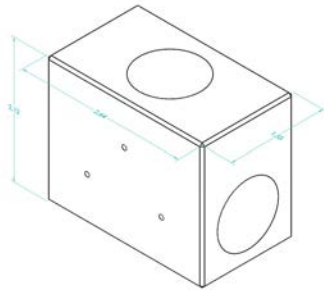

HPPA-HB-00T9

***Standard 9/16" Tee
H04-025-40-03016**

* All Fittings come with Gland Nuts and Collars

Inline Check Valve



HPPADVISORS



HPPA-HB-5701
Inline Check Valve Body
Assembly (Body, Nut, Spring,
Plug, Bullet)
H04-025-40-08017

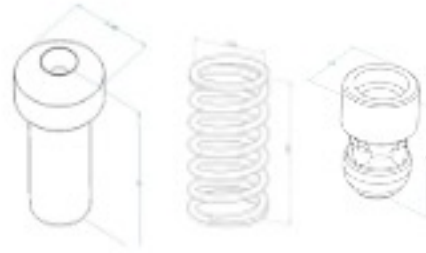

HPPA-HB-5701-6
Inline Check Valve Repair Kit
Plug, Spring, Bullet
H04-025-40-08016

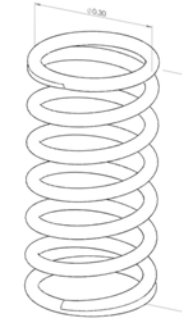

HPPA-HB-5701-4
Inline Check Valve Spring
H04-025-40-08018

Discharge Parts

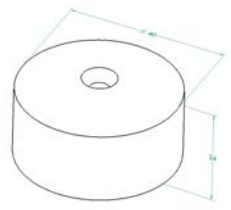

HPPA-HB-5904
Interchangeable Seat
H02-100-64-0110D

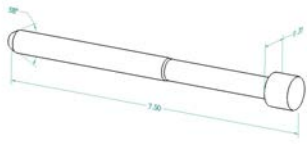

HPPA-HB-5905
Valve Closing Needle
H02-100-64-0090F



HPPA-HB-5906
Valve Insert
H02-100-64-0500D

Intensifier Parts



HPPADVISORS

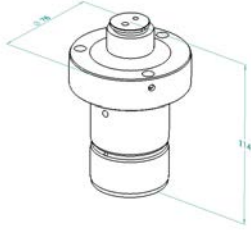

HPPA-HB-5804
Check Valve Body
D20-044-30-1012C

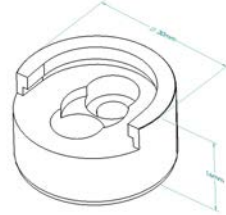

HPPA-HB-5808
Check Valve Cap
D20-044-30-2006C



HPPA-HB-5808-1
Poppet, Check Valve Low Pressure
H02-250-60-0130C

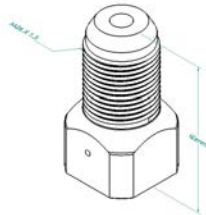

HPPA-HB-5805
HP Outlet (Check Valve)
H02-250-60-0090C

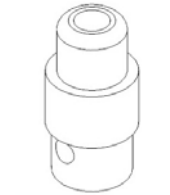

HPPA-HB-5805-2
Poppet, (Check Valve)
High Pressure
H02-250-60-2009C



HPPA-HB-5805-3
Guiding, Check Valve
Low Pressure
H02-250-60-0150C



HPPA-HB-5810
Water Jacket Sleeve
D20-044-30-1079C

Intensifier Parts



HPPADVISORS

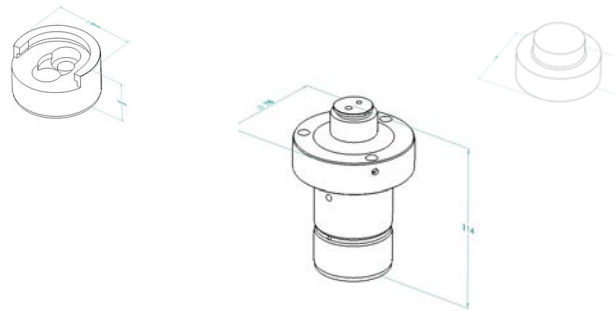

HPPA-HB-5804-1

Intensifier Repair Kit

Check Valve Body, Cap, Poppet Low Pressure

H02-250-60-1900E

Vessel Parts



HPPA-HB-5501

Sensor Measurement Spring Support

H02-100-71-0364C

Ask Us About our Full Line of 420L and 525L HPP Baskets, Basket Carriers and Handling Equipment



Contact Us for a Quote

Fittings: Contact Paige@HPPAdvisors.com

Aftermarket Hiperbaric Parts: E-Mail: Aftermarket@HiperbaricParts.com

Phone: 269-462-9730 Office Main Number
269-858-8301 Cell