



HPPADVISORS



2022 Aftermarket Equipment

Why HPP Advisors?



HPPADVISORS

“What is Truly Unique to our Approach is our Customer Inward Approach to product development and coming to Market”

- We source "Made in USA" first and foremost with Certified Suppliers
- Our customers are involved from Day 1 in bringing our Products to Market
- We stand behind our Parts with Industry only Cycle Warranty
- We offer a 15% Discount off the OEM List Price AND
 - Volume Discount Pricing
- Our Supply Chain Management ensures you have Parts when you need them!

Anticipated Life Span Calculations



All HPP Advisors parts come backed with a cycle warranty and anticipated Life Span. What does this mean to you, our customer?



Our Warranty is there to provide peace of mind as we know if a part is bad, it is going to go early in the cycle counts

Our Anticipated Life span is what our design projects out to and/or what Our customer feedback has told us

There are many variables that affect the life cycle life of ultra high-pressure parts.

- Proper installation and torque
- Process Water Quality
- Variable Pressures
- Variable Holds Times
- Machine Volume Size
- Part Placement
- And More.....

High Pressure Fittings

Compatible with the following HPP Equipment

Avure™/JBT

- AV10 (formerly 100L)
- AV-20M, 30M, 40M (formerly 350L)
- AV-40X, 50X, 60X, 70X
- 680L

Hiperbaric

- 55L
- 120L
- 135L
- 300L
- 420L
- 525L

Hypree

- 50L
- 150L
- 350L
- 525L



HPPADVISORS

- ✓ Operating Pressure 87k (6000 Bar)
- ✓ Excellent Mechanical Properties for Food Production Environments
- ✓ High Strength Stainless Steel with Good Corrosion Resistance
- ✓ Cone and Thread Connections
- ✓ Part Number, Serial Number Traceability

Fittings, Gland Nuts, Collars, Plugs



HPPADVISORS

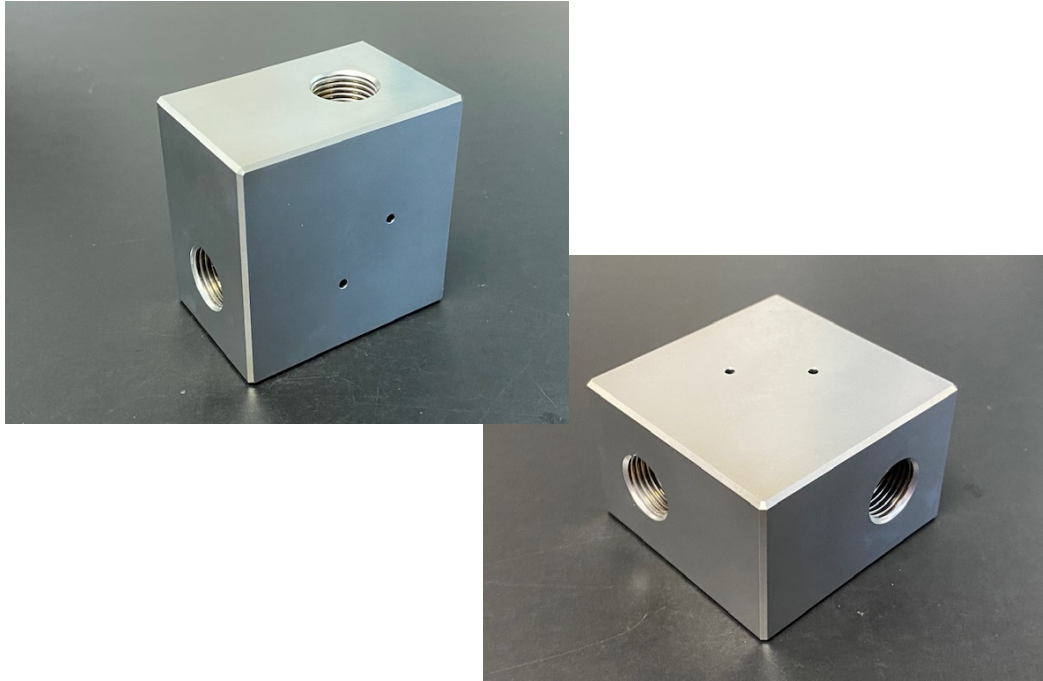

- ✓ Gland Nuts come standard with Hexagonal Heads



- ✓ Fittings come in any configuration of 9/16" x 3/8"



Plugs, Gland Nuts, Collars

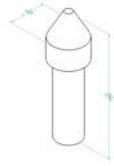

HPPA-00-00P3
Standard 3/8" Plug
Cross# H04-025-40-09002 &
100CP60

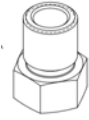

HPPA-00-00G3
Standard 3/8" Gland Nut
Cross# 100CGL60



HPPA-00-00C3
Standard 3/8" Collar
Cross# 100-CCL60 & Flow A-2839



HPPADVISORS

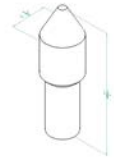

HPPA-AV-00P3
Flow 3/8" Plug
012252-1



HPPA-AV-00G3
Flow 3/8" Gland Nut
A-2838



HPPA-00-00C9
Standard 9/16" Collar
Cross# ACL90-155

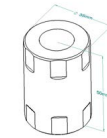

HPPA-00-PTA3
20mm to 3/8" Adapter



HPPA-00-00P9
Standard 9/16" Plug
Cross# H04-025-40-09001 &
100AP90-155



HPPA-00-00G9
Standard 9/16" Gland Nut
Cross# AGL90-155



HPPA-00-0093
Standard 3/8" to 9/16
Adapter
Cross# H04-025-40-05009 &
100M96B3-155

Fittings, Valves

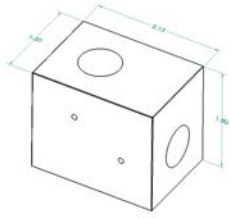

HPPA-00-00E3
*Standard 3/8" Elbow
Cross# H04-025-40-02006 &
100CL6600-155AP

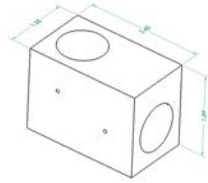

HPPA-00-00E9
*Standard 9/16" Elbow
Cross# 100CL9900-155AP &
H04-025-40-02002

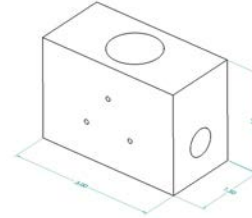

HPPA-00-OCT3
*Standard Combo
3/8" x 3/8" x 9/16" Tee
Cross# H04-025-40-03018

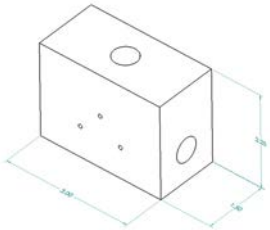

HPPA-00-00T3
*Standard 3/8" Tee
Cross# H04-025-40-03017 &
100CT6660-155

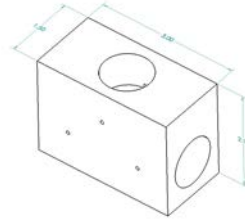

HPPA-00-00T9
*Standard 9/16" Tee
Cross# H04-025-40-03016 &
100CT9990-155AP

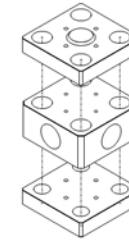

HPPA-AV-04W3
**Flow 3/8" Truss Cross
Cross# Flow 014523-1

* 8,000 Cycle Warranty, Anticipated Cycle Life 20,000 +

** 8,000 Cycle Warranty, Anticipated Cycle Life 20,000 +

Fittings, Valves

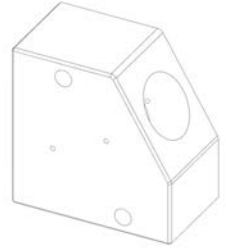

HPPA-HB-B6E9

*Standard 130 Degree
9/16" Elbow

Cross# H04-025-40-02004

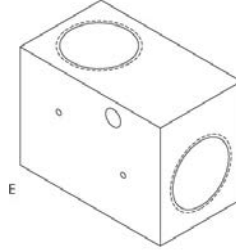

HPPA-HB-00E9

*Standard 9/16" Elbow

Cross# H04-025-40-02002

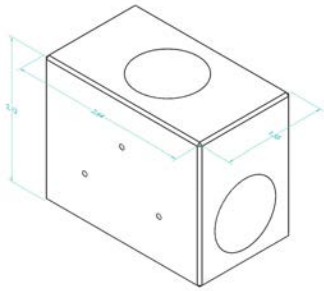

HPPA-HB-00T9

*Standard 9/16" Tee

Cross# H04-025-40-03016

* 8,000 Cycle Warranty, Anticipated Cycle Life 20,000 +

** 8,000 Cycle Warranty, Anticipated Cycle Life 20,000 +



Inline Check Valve



HPPADVISORS

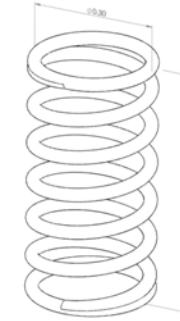
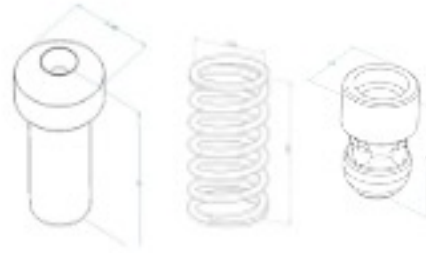

HPPA-HB-5701
Inline Check Valve Body
Assembly (Body, Nut, Spring,
Plug, Bullet)
Hiperbaric H04-025-40-08017

HPPA-HB-5701-6
Inline Check Valve Repair Kit
Plug, Spring, Bullet
Hiperbaric H04-025-40-08016

HPPA-HB-5701-4
Inline Check Valve Spring
H04-025-40-08018

* 8,000 Cycle Warranty, Anticipated Cycle Life 15,000 +

Ancillary Parts



HPPADVISORS



HPPA-00-PHP2

High Pressure Transducer 6100 bar
4 Pin Connection, 20mm Male
Cross# H04-036-50-03024

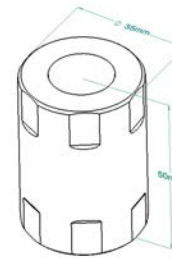

HPPA-00-PTA3

20mm to 3/8" Adapter
Comes with HPPA-00-PHP2

Hiperbaric Aftermarket Parts

Our Selection of Parts increases based upon customer demand.

If you don't see a part you are looking for let us know and we will do our best to fulfill your request!

We included below each part the Original Manufacture Part Number for your convenience!



HPPADVISORS



Discharge Parts



HPPADVISORS

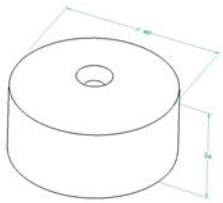

HPPA-HB-5904

**Interchangeable Seat
H02-100-64-0110D**

1,000 Cycle Warranty,
Anticipated Cycle Life 4,000 +

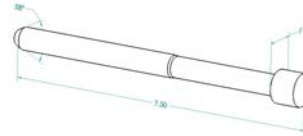

HPPA-HB-5905

**Valve Closing Needle
H02-100-64-0090F**

2,000 Cycle Warranty,
Anticipated Cycle Life 4,000 +



HPPA-HB-5906

**Valve Insert
H02-100-64-0500D**

3,000 Cycle Warranty,
Anticipated Cycle Life
15,000+

Intensifier Parts



HPPADVISORS

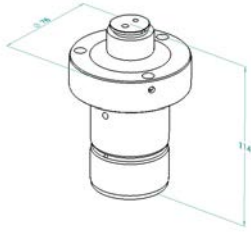

HPPA-HB-5804
Check Valve Body
D20-044-30-1012C

8,000 Cycle Warranty
Anticipated Cycle Life 35,000

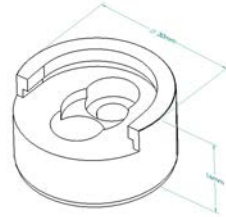

HPPA-HB-5808
Check Valve Cap
D20-044-30-2006C

8,000 Cycle Warranty
Anticipated Cycle Life 35,000+



HPPA-HB-5808-1
Poppet, Check Valve Low Pressure
H02-250-60-0130C

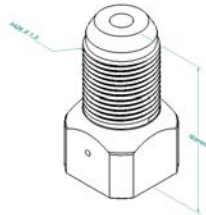

HPPA-HB-5805
HP Outlet (Check Valve)
H02-250-60-0090C

4,000 Cycle Warranty
Anticipated Cycle Life 20,000

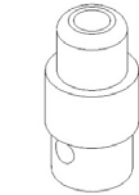

HPPA-HB-5805-2
Poppet, (Check Valve)
High Pressure
H02-250-60-2009C



HPPA-HB-5805-3
Guiding, Check Valve
Low Pressure



HPPA-HB-5810
Water Jacket Sleeve
D20-044-30-1079C

8,000 Cycle Warranty
Anticipated Cycle Life 35,000+

www.HPPAdvisors.com

Intensifier Parts



HPPADVISORS

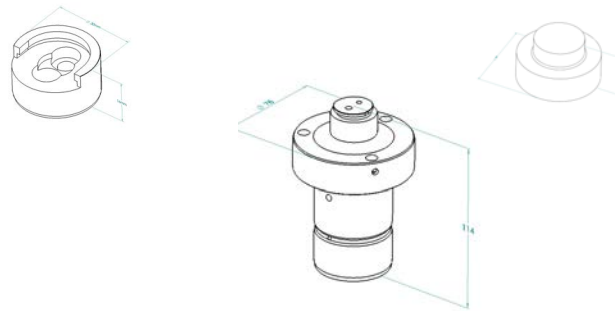

HPPA-HB-5804-1

Intensifier Repair Kit

Check Valve Body, Cap, Poppet Low Pressure

H02-250-60-1900E

8,000 Cycle Warranty

Anticipated Cycle Life 35,000

www.HPPAdvisors.com

Vessel Parts



HPPA-HB-5501

Sensor Measurement Spring Support

H02-100-71-0364C

Avure/Flow/KMT Aftermarket Parts

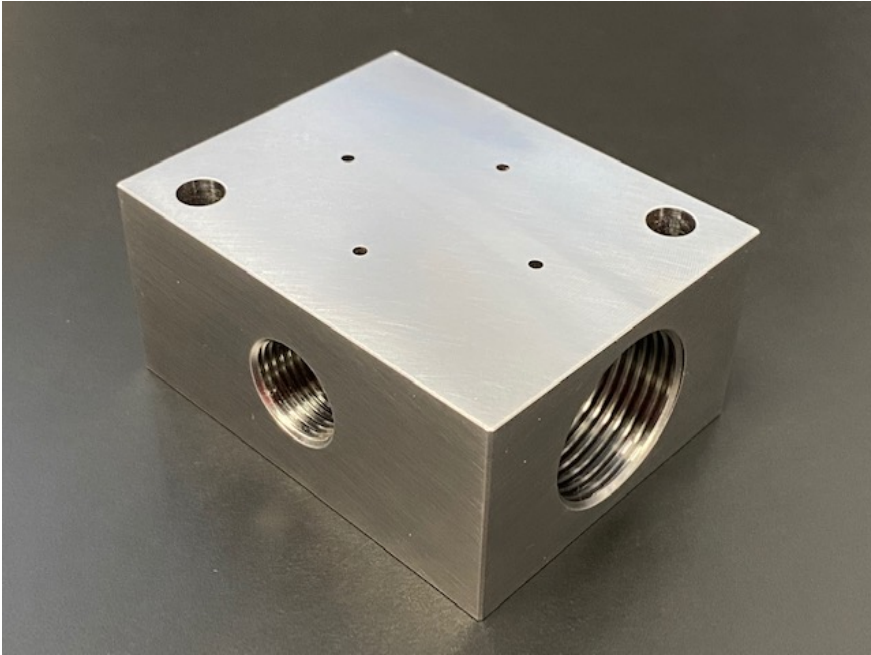

Our Selection of Parts grows based on upon customer demand.

If you don't see a part you are looking for let us know and we will do our best to fulfill your request!

We included below each part the Original Manufacture Part Number for your convenience!

Intensifier Parts

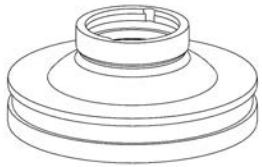

HPPA-AV-5803
Carrier Seal
040015-1

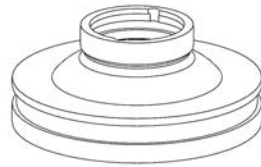

HPPA-KMT-5803
Carrier Seal
ATO1381

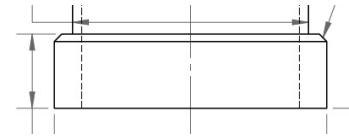

HPPA-AV-5803-1
Replacement Bushing

Decompression Parts

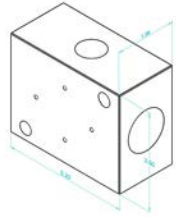

HPPA-AV-5901
Bleed Down Body
011742-1

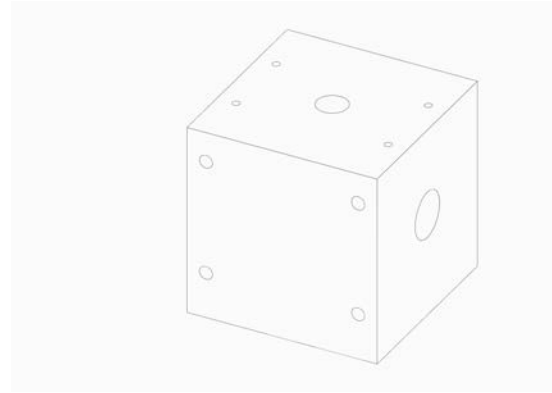

HPPA-KM-5901
Discharge Block
ATO1230

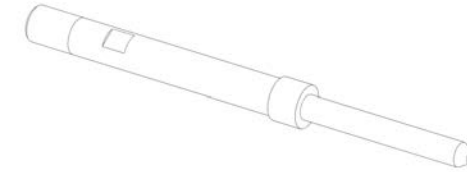

HPPA-KM-5902
Discharge Stem UHP
Water VLV
ATO1230



HPPA-KM-5904
PKG Assy UHP VLV 7 Pieces
ATO1232



HPPA-KM-5905
PKG FOL VLV Stem Assy
ATO1231



HPPA-KM-5906
Seat UHP VLV Assy
ATO1233

Plug Parts

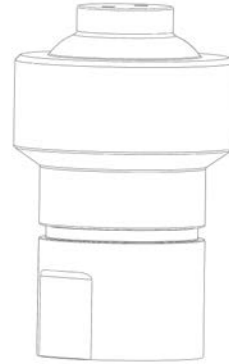

HPPA-KM-0VCP
Plug Check Valve
ATO1413

Contact Us for a Quote

Fittings: Contact Paige@HPPAdvisors.com

Aftermarket Hiperbaric Parts: Contact Aftermarket@HiperbaricParts.com

Aftermarket Flow/Avure™/JBT Parts: Contact Aftermarket@AvureParts.com

Phone: 269-462-9730