



2020 Aftermarket Equipment  
Catalog

# Why HPP Advisors?



**HPPADVISORS**

*“What is Truly Unique to our Approach, is our team is hands-on, day to day operating machines. We are Focused on the Pain Points from a User Perspective.”*

- We source "Made in USA" first and foremost
- We stand behind our Parts with Industry only Cycle Warranty
- Leadership Team is passionate about HPP from process to parts...
- Driven to lower cost of ownership of HPP Equipment.
- Customer focused team with years of experience operating and servicing HPP equipment.
  - “Can Do” mindset to insuring customer needs are met!
  - Focused on Solutions vs. Selling Parts

# COMPARE THE VALUE



FEATURES	Parker AutoClave	Hiperbaric	JBT/ Avure™	Maximator	HPP Advisors
All Fittings are Made in USA	?	?	?	?	X
Traceability	X		X	X	X
Total Order Volume Pricing (Fittings and Wear Parts)					X
60 Day/8k Warranty - Fittings					X
All Fittings come with Collar and Gland	X	X	X	X	X
Core Fee Applied to Future Order					X
Quarterly Failure/Trend Analysis					X
DIY Video's	X	X	X	X	X
Onsite Wear Parts Assessment/Strategy					X

# High Pressure Fittings

Compatible with the following HPP Equipment

## Avure™/JBT

- AV10 (formerly 100L)
- AV-20M, 30M, 40M (formerly 350L)
- AV-40X, 50X, 60X, 70X
- 680L

## Hiperbaric

- 55L
- 120L
- 135L
- 300L
- 420L
- 525L

## Hypree

- 50L
- 150L
- 350L
- 525L



**HPPADVISORS**

- ✓ Operating Pressure 87k (6000 Bar)
- ✓ Excellent Mechanical Properties for Food Production Environments
- ✓ High Strength Stainless Steel with Good Corrosion Resistance
- ✓ Cone and Thread Connections
- ✓ Working Pressure, Part Number, Serial Number Traceability

# Fittings, Gland Nuts, Collars, Plugs



**HPPADVISORS**

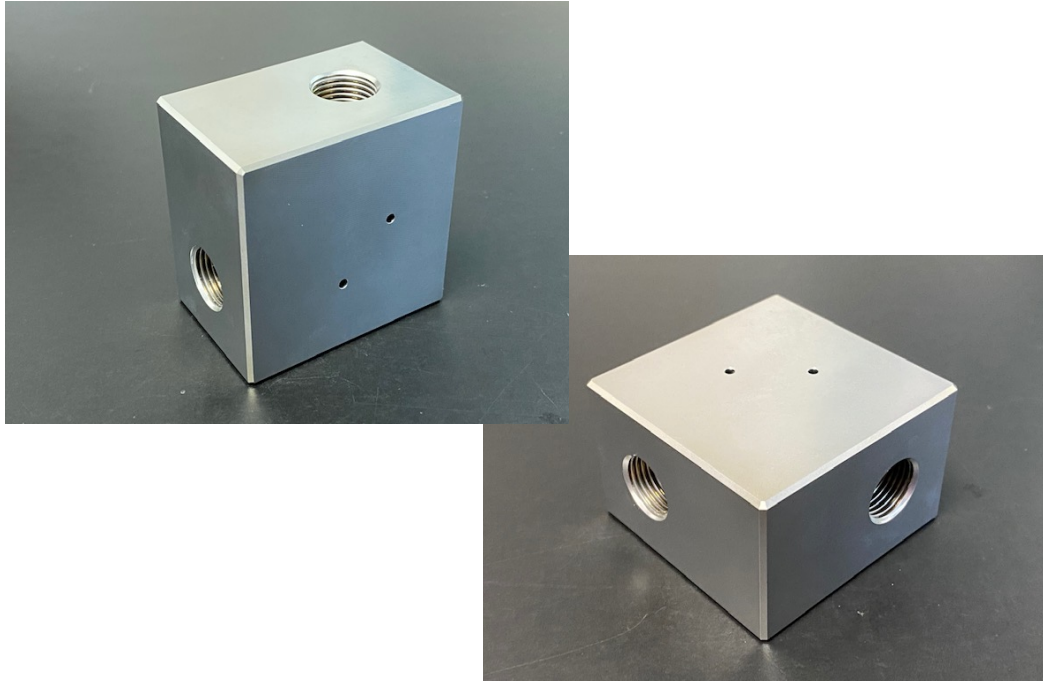

- ✓ Fittings come in any configuration of 9/16" x 3/8"

- ✓ Gland Nuts come standard with Hexagonal Heads

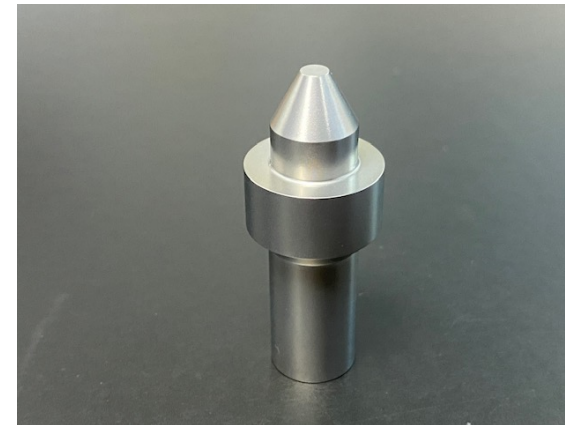

# Plugs, Gland Nuts, Collars

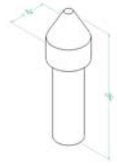

HPPA-00-00P3  
Standard 3/8" Plug

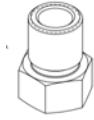

HPPA-00-00G3  
Standard 3/8" Gland Nut



HPPA-00-00C3  
Standard 3/8" Collar



**HPPADVISORS**

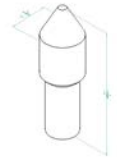

HPPA-AV-00P3  
Flow 3/8" Plug



HPPA-AV-00G3  
Flow 3/8" Gland Nut



HPPA-00-00C9  
Standard 9/16" Collar



HPPA-00-PTA3  
20mm to 3/8" Adapter

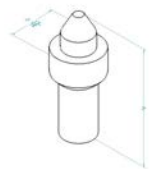

HPPA-00-00P9  
Standard 9/16" Plug



HPPA-00-00G9  
Standard 9/16" Gland Nut



HPPA-00-0093  
Standard 3/8" to 9/16  
Adapter



HPPA-AV-00G3  
Flow 3/8" Gland  
Nut  
[www.HPPAdvisors.com](http://www.HPPAdvisors.com)

# Fittings, Valves

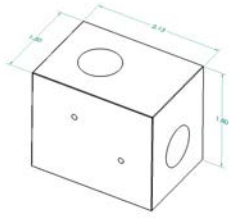

**HPPA-00-00E3**  
Standard 3/8" Elbow

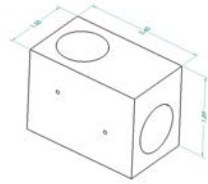

**HPPA-00-00E9**  
Standard 9/16" Elbow  
Cross to H04-025-40-02002

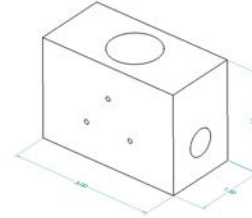

**HPPA-00-OCT3**  
Standard Combo  
3/8" x 3/8" x 9/16" Tee  
Cross to H04-025-40-03018

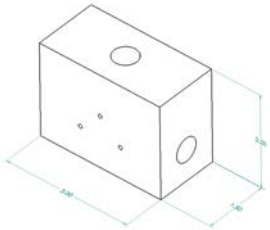

**HPPA-00-00T3**  
Standard 3/8" Tee  
Cross to H04-025-40-03017

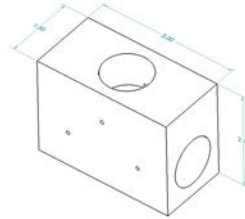

**HPPA-00-00T9**  
Standard 9/16" Tee  
Cross to H04-025-40-03016

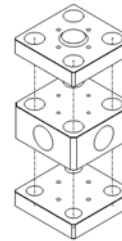

**HPPA-AV-04W3**  
Flow 3/8" Truss Cross  
Cross to 014523-1

# Fittings, Valves

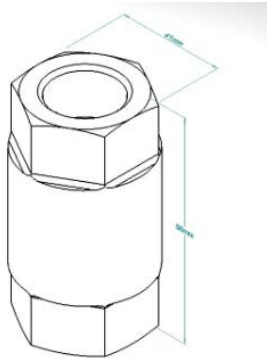

**HPPA-HB-5701**  
Inline Check Valve Body  
H04-025-40-08017

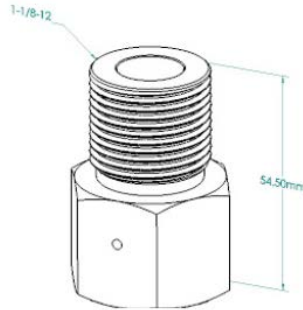

**HPPA-HB-5701-2**  
Inline Check Valve Body Nut  
H04-025-40-08011\*

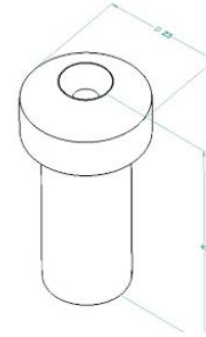

**HPPA-HB-5701-3**  
Inline Check Valve Body Plug  
H04-025-40-08011\*

\* Sold Individually or as Kit



# Ancillary Parts



**HPPADVISORS**



**HPPA-00-PTHP2**

High Pressure Transducer 6100 bar  
4 Pin Connection, 20mm Male

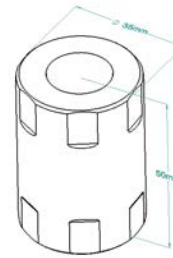

**HPPA-00-PTA3**

20mm to 3/8" Adapter  
Comes with HPPA-00-PTHP2

# Hiperbaric Aftermarket Parts

Our Selection of Parts increases based upon customer demand.

If you don't see a part you are looking for let us know and we will do our best to fulfill your request!

We included below each part the Original Manufacture Part Number for your convenience!



**HPPADVISORS**



# Discharge Parts



**HPPADVISORS**

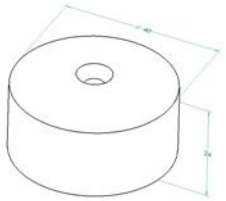

**HPPA-HB-5904**  
Interchangeable Seat  
H02-100-64-0110D

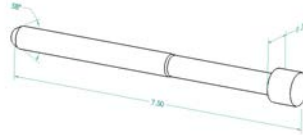

**HPPA-HB-5905**  
Valve Closing Needle  
H02-100-64-0090F



**HPPA-HB-5906**  
Valve Insert  
H02-100-64-0500D

# Intensifier Parts



**HPPADVISORS**

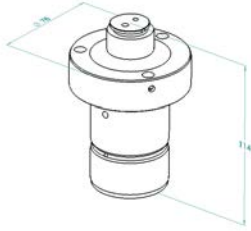

**HPPA-HB-5804**  
Check Valve  
D20-044-30-1012C

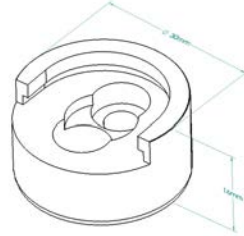

**HPPA-HB-5808**  
Check Valve Cap  
D20-44-30-2006C

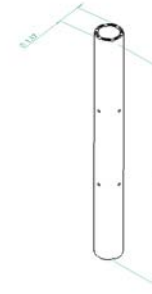

**HPPA-HB-5810**  
Water Jacket Sleeve  
D20-044-30-1079C

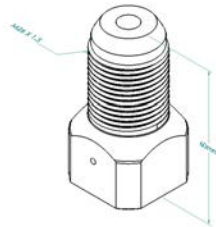

**HPPA-HB-5805**  
HP Outlet (Check Value)  
H02-250-60-0090C

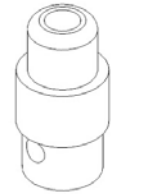

**HPPA-HB-5805-2**  
Poppet, (Check Valve) High Pressure  
H02-250-60-2009C



**HPPA-HB-5805-3**  
Poppet, Check Value Low Pressure  
H02-250-60-0130C

# Intensifier Parts coming 2<sup>nd</sup> Qtr 2021



**HPPADVISORS**

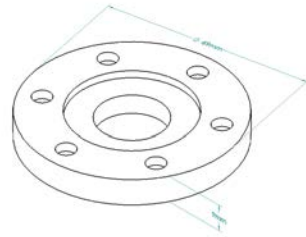

**HPPA-HB-5806**  
Hydraulic Seal Cap  
D20-050-10-0003C

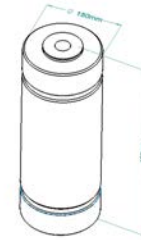

**HPPA-HB-5809**  
High Pressure Jacket  
H02-250-60-1040C

# Vessel Parts



HPPA-HB-5501

Sensor Measurement Spring Support

H02-100-71-0364C

# Avure/Flow Aftermarket Parts

Our Selection of Parts grows based on upon customer demand.

If you don't see a part you are looking for let us know and we will do our best to fulfill your request!

We included below each part the Original Manufacture Part Number for your convenience!

# Intensifier Parts



HPPA-AV-5801  
Low Pressure Cylinder  
011290-1



HPPA-AV-5803  
Carrier Seal – Refurb  
040015-1



HPPA-AV-5807/5808 L/R  
Bell End  
019684-1/019683-1



HPPA-AV-5802  
Piston Assembly  
200079-1

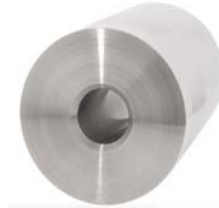

HPPA-AV-5804  
87k Intensifier High Pressure  
Cylinder Long Block – Refurb  
020592-1



HPPA-AV-5808  
Plunger  
010253-1



# Intensifier Parts



HPPA-AV-5919

Check Valve Body  
020077-1



HPPA-AV-5820

Minor Maintenance Kit with  
refurb seal  
058033-1



HPPA-AV-5822

Check Valve Outlet Replacement  
014885-1



HPPA-AV-5821

Check Valve Inlet Replacement  
014885-1



HPPA-AV-5815

Filler Tube  
020595-1

# Decompression Parts



HPPA-AV-5901  
Bleed Down Body  
011742-1



HPPA-AV-5903  
Valve Poppet  
012584-1



HPPA-AV-5902  
Bleed Down Valve  
Actuator  
012763-1



HPPA-AV-5905  
Blow Down Valve  
Adapter  
013052-1



HPPA-AV-5906  
Connector  
A-0636-6



HPPA-AV-5907  
Reducer  
A-0635-11



HPPA-AV-5908  
Bleed Down Valve  
Actuator Housing  
012761-1



HPPA-AV-5909  
Insert  
012762-1

# Contact Us for a Quote

Fittings: Contact Paige@HPPAdvisors.com

Aftermarket Hiperbaric Parts: Contact Aftermarket@HiperbaricParts.com

Aftermarket Flow/Avure™/JBT Parts: Contact Aftermarket@AvureParts.com